



CHENGDU ROSUN DISINFECTION

DW-1 Product Introduction

Makes The
Rivers And Earth Cleaner
Helps Billions
Of People Be Healthier

- 1 History of Disinfection
- 2 DW-1 product introduction
- 3 Authority Certificates
- 4 Application and Facilities
- 5 Achievements in China
- 6 Study Case in Malaysia

1

History of Disinfection

➤ **Outbreaks of a series of infectious disease in history because there is no disinfection**

- Outbreak of plague (Black Death) in the 14th century ,killing half the Europeans, it repeatedly broke out and didn't stop until the 18th century.
- In 1816, for the first time in human history, cholera pandemic broke out in Bangladesh and India.
- British cholera pandemic in 1831, affecting almost the half of the Eastern Hemisphere.
- Chicago cholera pandemic in 1885,claimed 90,000 lives.
- European Influenza (1917~1919) resulted in 50 million deaths.

➤ **Disease have been prevented by disinfection**

- SARS
- Bird Flu
- Ebola
- EMS WSDV

Water quality become worse, and water pollution more and more serious

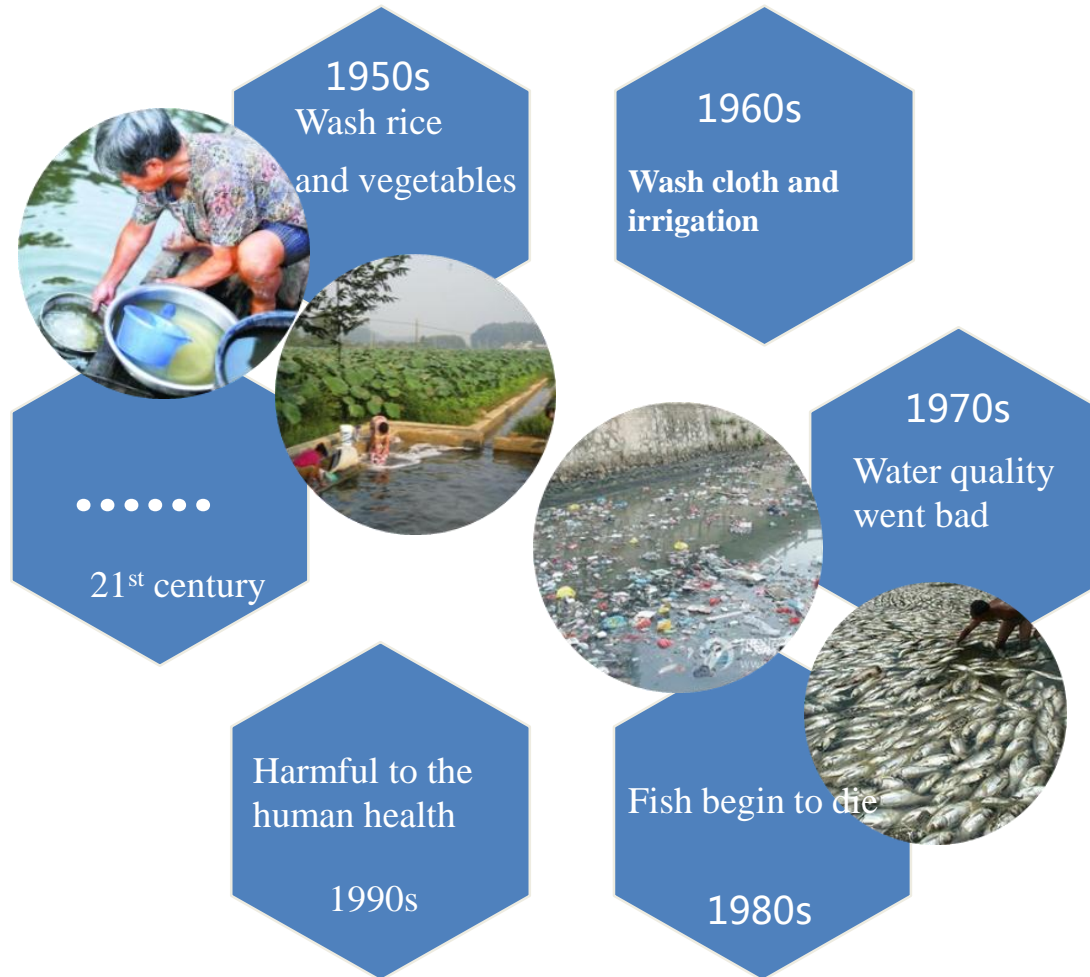

Such kind of water

Have you used?

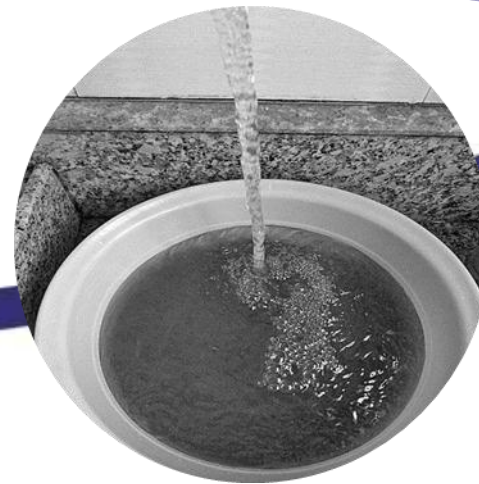

Chemical by-product Problem

When use disinfectant in bad quality water, it will produce a large amount of chemical by-products when meet the organic matter in water.

- Chlorine and its compound, bromine, iodine: THM ,chlorinated disinfection byproduct, doesn't exist in natural water, and is only produced in chlorinated disinfection process. Currently there are over 500 kinds of chlorine disinfection by-products that have been confirmed.
- $\text{HOCl} + \text{Br} + \text{NOM} = \text{THMS} + \text{other haloforms}$
- NOM: Natural organics humic acid and fulvic acid
- THMS: trihalomethanes
- Chlorine dioxide: causing chlorite
- Ozone: bromate is level-2B potential carcinogen, which can be obtained by ozone oxidized into bromine ion, $\text{Br} + \text{O}_3 \rightarrow \text{BrO}_3$

Chemical by-product Problem

- Main chlorine-induced toxic substances confirmed by WHO include:
 1. Carcinogen:
 - THMS, HAAS, halogenated cyanide, haloaldehydes, phenol, etc.
 - HAAS: DCAA's carcinogenic risk is 50 times of THMS.
 - TCAA: its carcinogenic risk is 100 times of THMS.
 2. Mutagenicity: typical liver, kidney and bladder mutagenicity of chloroform, bromoform, furaneol, (monobromo-dichloro-methane, dibromo-monochloro-methane)
 3. Suspected carcinogenic substances: dichloroacetic acid, bromate, formaldehyde

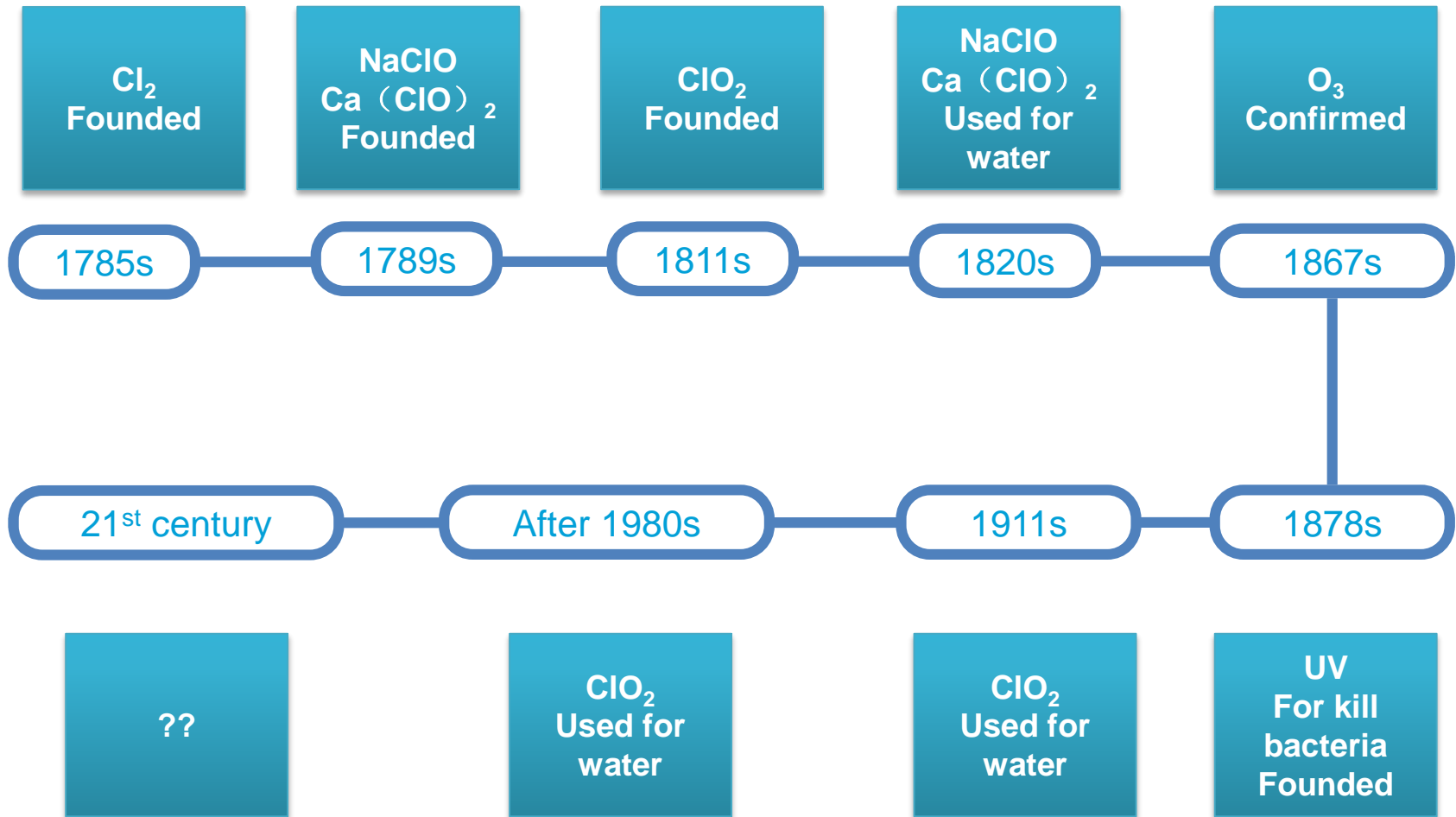

➤ **The existing disinfection in the market**

A: Chlorine(Liquid Chlorine, Calcium Hypochlorite, Sodium hypochlorite, etc.)

- ❖ Low price
- ❖ Danger By-products (carcinogenic, mutagenic and suspected carcinogenic substances)
- ❖ Store and transport difficulty
- ❖ Leakage
- ❖ Flammable and combustible

D: Ultraviolet

- ❖ Good sterilization effect
- ❖ Big influence from floats in water
- ❖ High cost
- ❖ Shall be frequently changed

C: Ozone

- ❖ Good sterilization effect
- ❖ No enduring effect
- ❖ Complex preparation
- ❖ High cost
- ❖ Produce Bromate

B: Chlorine dioxide

- ❖ Good effect and long duration
- ❖ Difficult to store
- ❖ Shall be prepared on site for use
- ❖ Expensive cost
- ❖ Disinfection by-products produced due to complex test technology

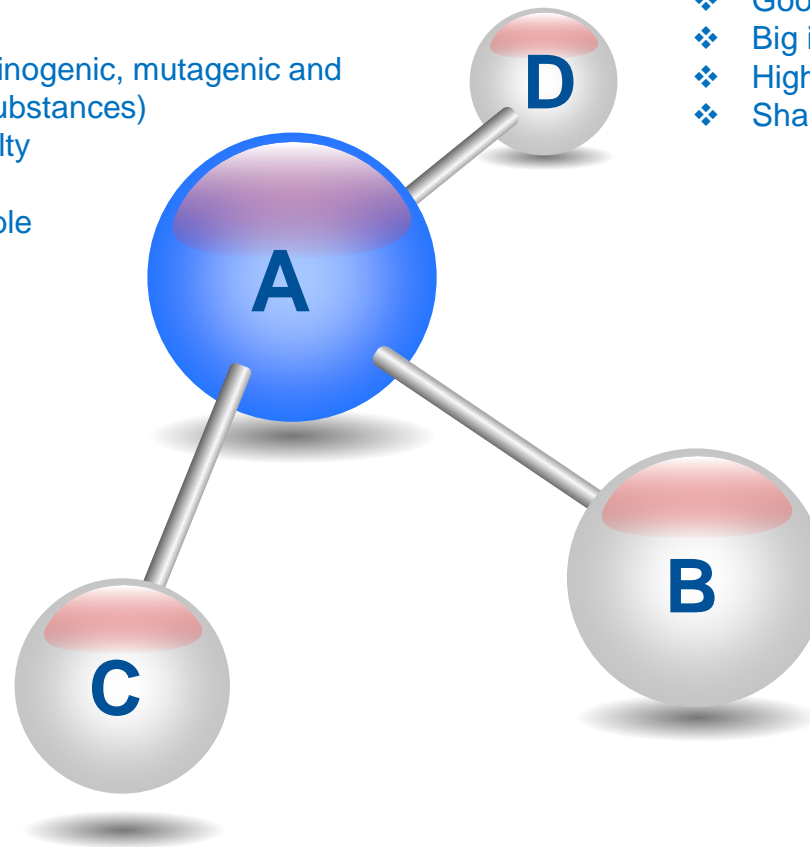

What kind of disinfection method the water company calls for?

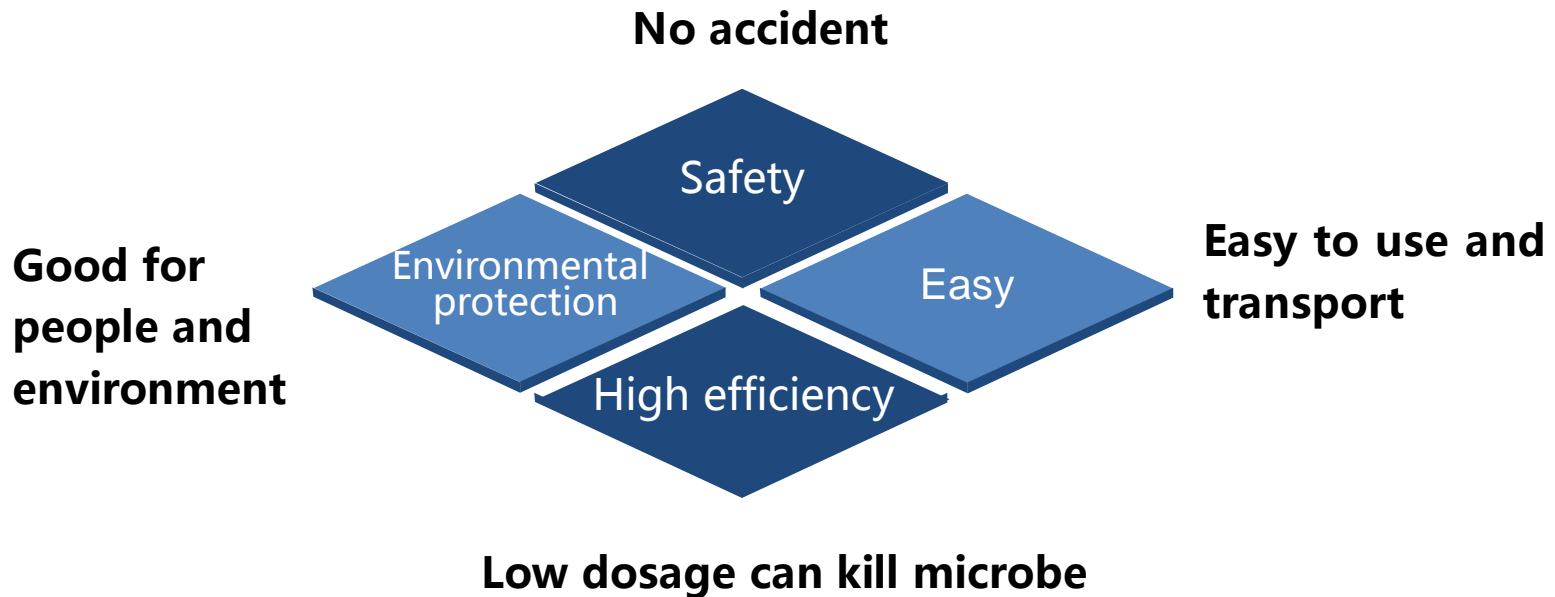

The potassium monopersulfate disinfectant has the advantages shows above.

2

DW-1 product introduction

Potassium monopersulfate triple salt (PMPS)

- In the early 1990s, British use PMPS to treat the foot and mouth disease which spread in European countries, and get excellent result, then European countries started the research of PMPS product, and the series product get used in rapidly.
- Then the different countries have promoted the standard for this chemical:
 - In 2000, Germany promoted national standard, standard No, DIN EN 12678:2000
 - In 2001, France promoted national standard, standard No. NF T94-309-2001
 - In 2002, British promoted national standard, standard No. BS EN 12678

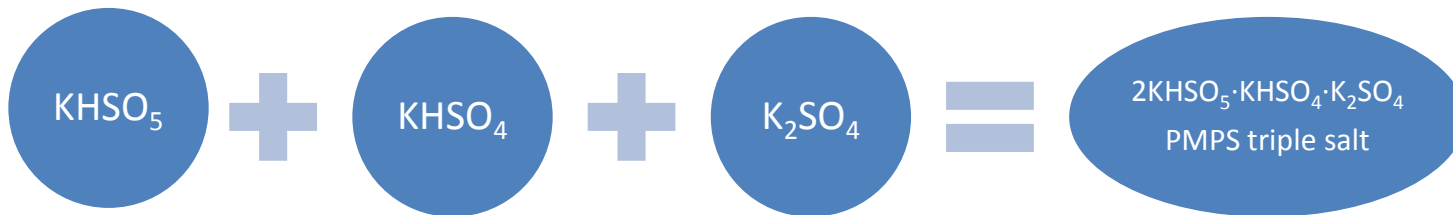

- But as PMPS is not stable, when dissolve in water, it will quickly release oxygen and potassium sulfate, no long lasting efficacy, so usually it used as oxidizer or oxygen supply chemical in aquaculture.

- **Rosun disinfectant powder DW-1 core mechanism**
- Rosun use special synergistic activation technology by add activator, synergist, stabilizer inside PMPS, so it is more stable, high efficacy and long lasting.

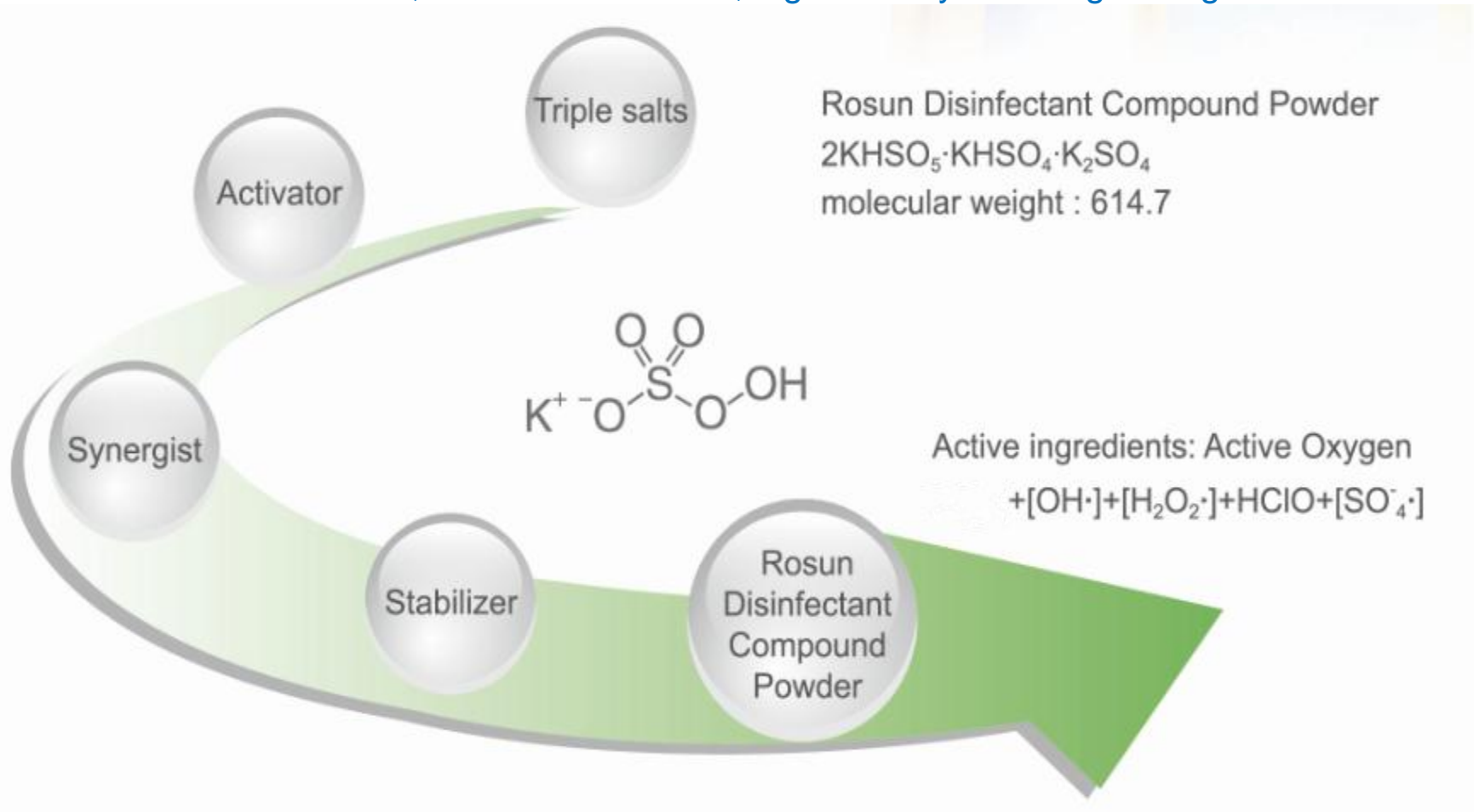

➤ **Rosun DW-1--- A new generation disinfection**

- Name : Rosun DW-1
- Main components : potassium monopersulfate
- Chemical formula : $2\text{KHSO}_5 \cdot \text{KHSO}_4 \cdot \text{K}_2\text{SO}_4$
- Physical property : white powder
- Solubility: soluble in water



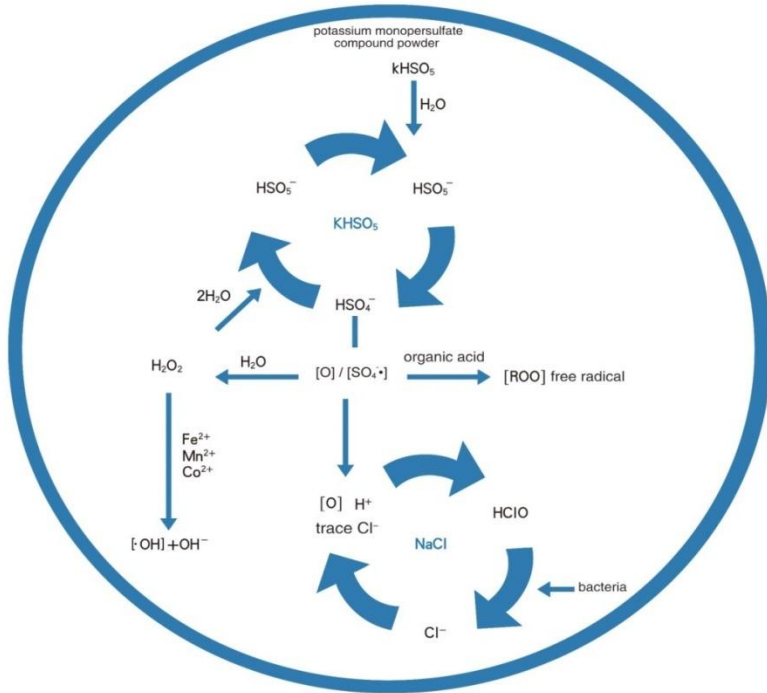

Cycle chain reaction—
long lasting efficacy

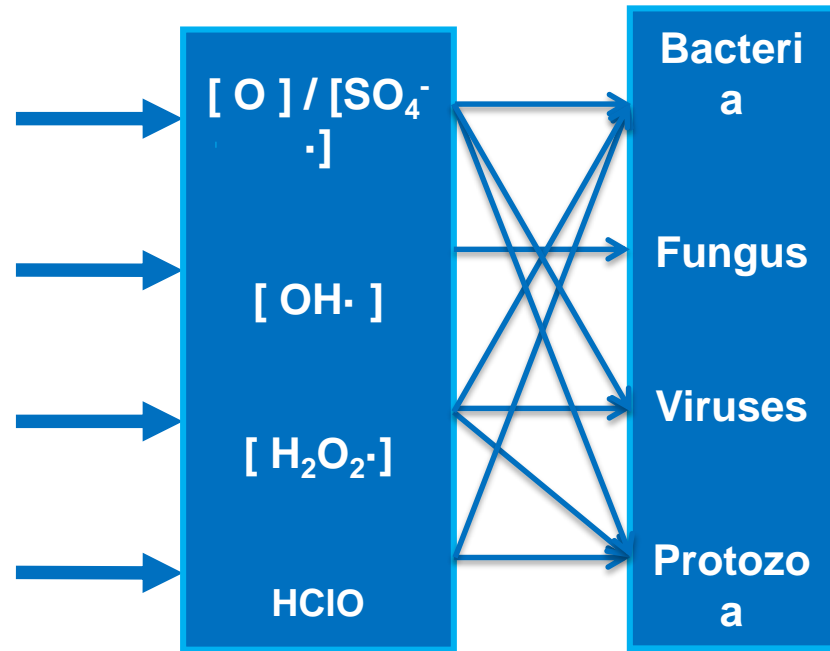

Different kinds of active ingredients — Broad Spectrum

Oxidizing Agent	F ₂	·OH	SO ₄ ·-	O ₃	O	H ₂ O ₂	ClO ₂	HClO	Cl ₂
Oxidation Potential	3.06	2.80	2.5-3.1	2.07	1.84	1.77 (pH<7)	1.5	1.48	1.36

High oxidation Potential—High efficacy

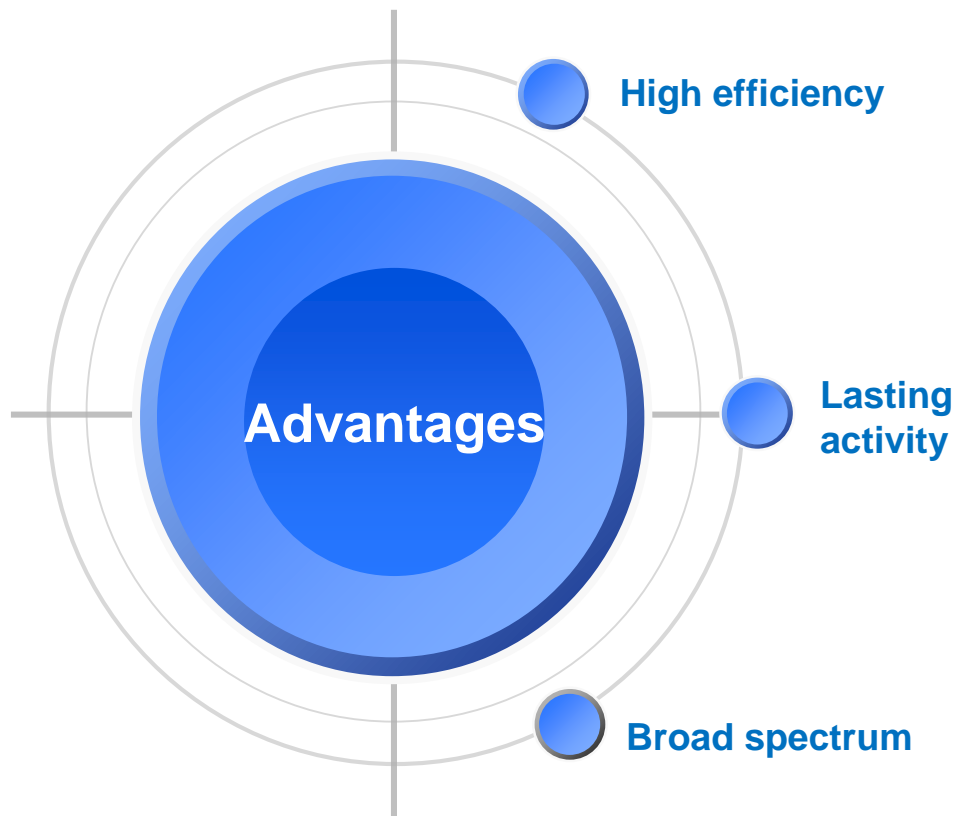

- Continuously produce active ingredients, sterilization over 99.9% bacterial.

- Release active ingredients continuously, efficacy last for lone time.

- Many active ingredients make this product have super broad-spectrum sterilization effect, the antibacterial spectrum includes bacteria, viruses, fungi, bacteria spores, protozoa, algae spores, etc.

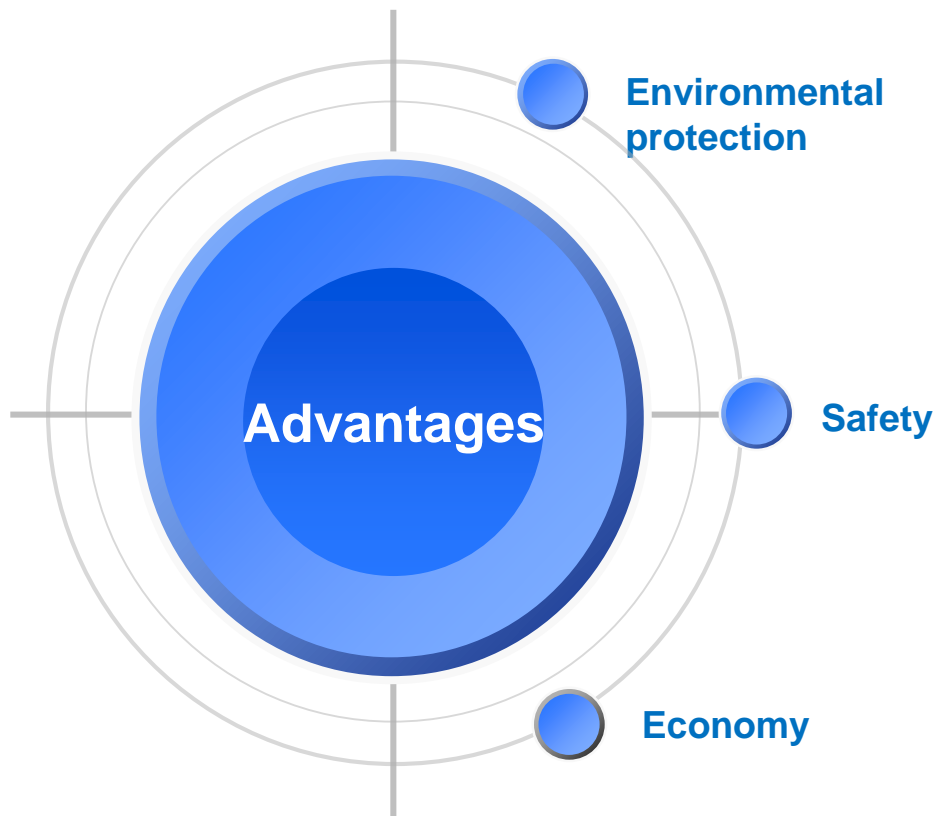

- Rosun disinfectant powder can reduce and prevent the production of harmful substances that may lead to carcinogenesis, teratogenesis and mutagenesis, such as organic chloride.

- This product is a powder disinfectant, so there is no danger during the production, transportation, storage and application which liquid chlorine caused.

- Lower disinfectant consumption, higher equipment cost-effective, longer service life and low maintenance cost.

3

Authority Certificates

Standard/Guidance

National Health and Family Planning Commission of P.R.C. in January 6, 2014 list potassium monopersulfate salt as a disinfectant for drinking water, and announced through National Hygiene Announcement [2013] No. 11 file (words in Red)

Form4 Main ingredient list of chemical agent

No.	Main Ingredient Name	Usage
1	Poly dimethyl diallyl ammonium chloride	flocculation
2	polyacrylamide	flocculation
3	aluminium salt	flocculation
4	ferric salt	flocculation
5	calcium hydroxide	coagulation aid、 pH adjustment
6	silicate	coagulation aid、 anti-scale
7	potassium permanganate	Disinfection、 oxidation
8	polyphosphates	Anti-scale
9	Sodium hypochlorite, calcium hypochlorite	coagulation aid、 disinfection
10	Potassium mono-perosulfate salt	Disinfection
11	sodium dichloro isocyanurate , trichloroisocyanuric acid※	Disinfection
12	chlorine dioxide	oxidation 、 Disinfection
13	hydrogen peroxide	oxidation 、 Disinfection
14	ammonium sulfate	Disinfection
15	Sulfites class	reducing agent

※ Only a few used when in emergency

Standard/Guidance

Extract content:

Potassium monopersulfate (DW-1) Sterilization characteristics

- The concentration of the Active oxygen is 7%-9%. only need 15min to kill most microorganism in water.
- Cycled chain reaction in water, continuous release Active oxygen and other Free Radical, so the Sterilization effect can last for long time in water.
- Different active ingredients coexist together, which lead to broad spectrum
- The killing effect is hardly influenced.
- Not produce harmful residue, only little K^+ , SO_4 contribution.

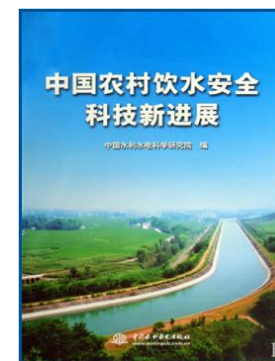

Disinfection License of Product Involving Drinking Water Safety



Product approval



Award of High and new Technology Product





Disinfection
Specialist

NSF Certification



NSF certificate



NSF test report

Reach Test Report



**Test Report
(SVHC)**

No. NGBHG1404330301 Date: 22 Dec 2014 Page 1 of 13

CHENGDU ROSUN DISINFECTANT PHARMACEUTICAL CO.,LTD
NO.139EAST FIFTH RD,OF AUTO CENTRE, ECO&TECH DEVELOPMENT ZONE OF CHENGDU CITY,
CHINA, 610100

The following sample(s) was/were submitted and identified on behalf of the clients as : ROSUN DISINFECTANT
POWDER DW-1 FOR DRINKING WATER

SGS Job No. : NBHG1412005244SD - NB

Date of Sample Received : 16 Dec 2014

Testing Period : 16 Dec 2014 - 22 Dec 2014

Test Requested : As requested by client, SVHC screening is performed according to:
(i) One hundred and fifty five (155) substances in the Candidate List of
Substances of Very High Concern (SVHC) for authorization published by
European Chemicals Agency (ECHA) on and before Jun 16, 2014 regarding
Regulation (EC) No 1907/2006 concerning the REACH.

Test Results : Please refer to next page(s).

Summary :

According to the specified scope and analytical techniques, concentrations of tested SVHC are \leq 0.1% (w/w) in the submitted sample.	PASS
---	------

Signed for and on behalf of
SGS-CSTC Ltd.

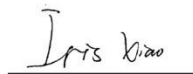

Iris Xiao
Approved Signatory



SGS-TESTING SERVICE
Ningbo Branch Laboratory

This document is issued by the Company subject to its General Conditions of Service printed overleaf, available on request or accessible at <http://www.sgs.com/en/Terms-and-Conditions.aspx> and, for electronic format documents, subject to Terms and Conditions for Electronic Documents at <http://www.sgs.com/en/Terms-and-Conditions/Terms-e-Documents.aspx>. Attention is drawn to the limitation of liability, indemnification and jurisdiction issues defined therein. Any holder of this document is advised that information contained herein reflects the Company's findings at the time of its intervention only and within the limits of Client's instructions, if any. The Company's sole responsibility is to its Client and this document does not exonerate parties to a transaction from exercising all their rights and obligations under the transaction documents. This document cannot be reproduced except in full, without prior written approval of the Company. Any unauthorized alteration, forgery or falsification of the content or appearance of this document is unlawful and offenders may be prosecuted to the fullest extent of the law. Unless otherwise stated the results shown in this test report refer only to the sample(s) tested.

Attention: To check the authenticity of testing, inspection report & certificate, please contact us at telephone: (86-755) 8387 1443, or email: CN_DocCheck@sgs.com

152 West Valley Drive, Singapore 627177 | Singapore Branch Registration No. 315040 | E&E: (86-574) 88070224 | E&E: (86-574) 87782095 | www.sgs.com | www.sgs.com.cn | 中国·宁波·国家高新区梁辉路1177号五丰产业园4号楼1-25层 邮编: 315040 | TEL: (86-574) 88070209 | FHL: (86-574) 87768122 | sgs.china@sgs.com

Member of the SGS Group (SGS SA)

➤ **China test results (Drinking Water test experiment)**

1 **Test of sterilization
active ingredients**

Average active oxygen content of the batch No.
20060928 sample is 8.41% (m/m).

3 **Dose Assessment**

The solution of 25mg/L product, the arsenic content is 0.0021mg/L, plumbum content is 0.0013mg/L, chrome content is 0.0025mg/L, cadmium content is 0.00095mg/L, silver content is 0.0011mg/L, and mercury content is 0.00017mg/L. All the content corresponds to Ministry of Health *Drinking Water Health Standards (2001)* requires.

2 **Disinfection Effect Test
For Drinking Water treatment**

The distilled water adding standard bacteria, then add product to 0.25mg/L concentration, disinfection for 15, 30, 45 minutes, at each time point were not detected escherichia coli. According to the results, the water disinfection with the product correspond to escherichia coli index of Ministry of Health *Drinking Water Health Standards (2001)* requires.

4 **Overall Performance Test**

The raw water add 5mg/L product, after disinfection for 30min, all the test items correspond to Ministry of Health *Drinking Water Health Standards (2001)* requires.

4

Application and Facilities

➤ DW-1 process flow

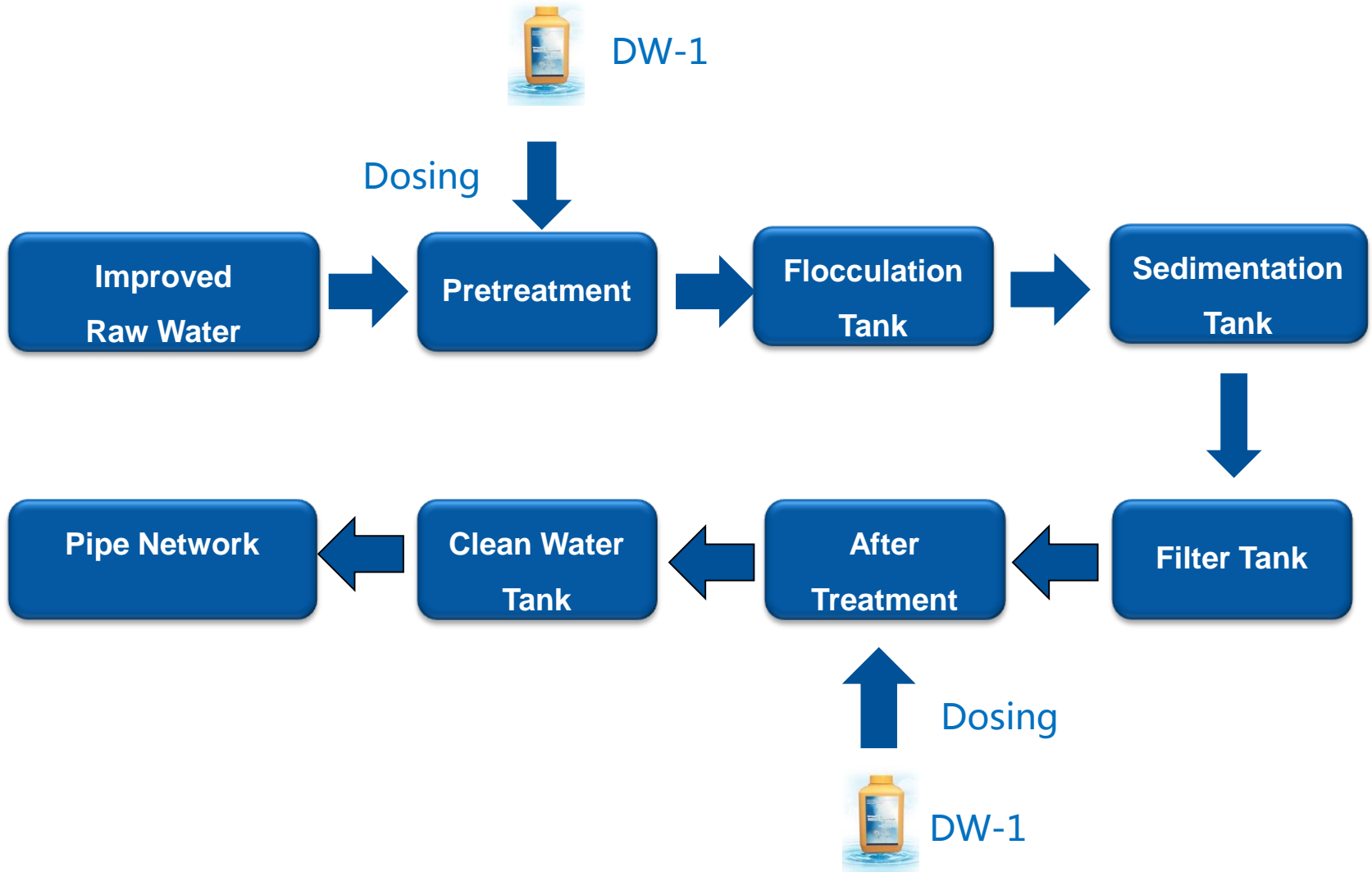

➤ **Dosing equipment**



Optimized type



High-end type

Equipment Principle

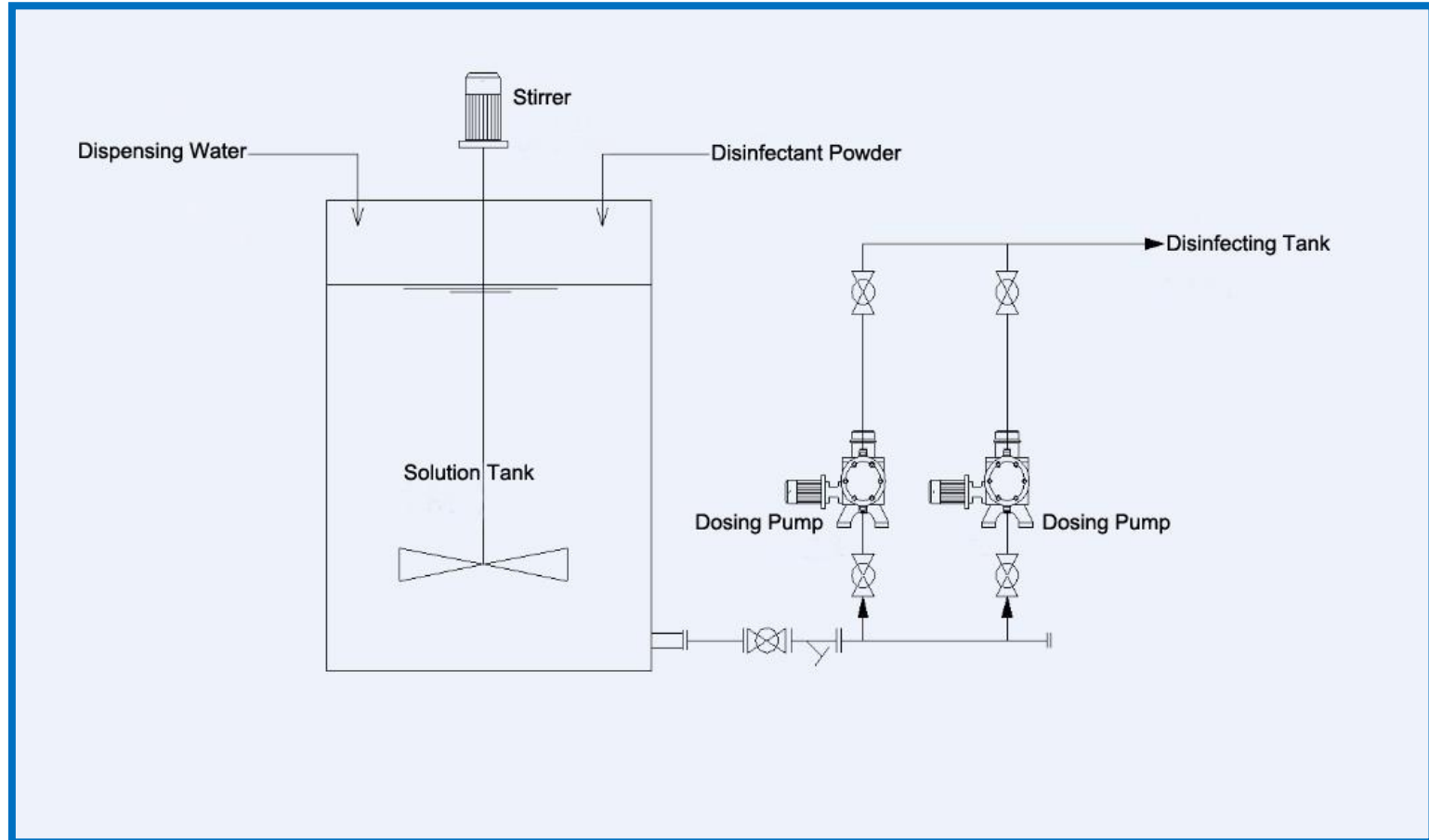

The equipment principle is quite simple, can refit the recent dosing equipment or build a simple dosing system.

➤ Active Ingredient Tester

1. Take a certain amount of sample water by colorimetric cylinder, add 1 pack of test kit, shake up to make it dissolve completely.
2. Wipe off the water and fingerprint on the colorimetric cylinder, after the bubble gone, compare the color with the card.



The active ingredient tester can show the bacteria situation in water indirectly, it is very easy to bring and use.

5

Achievements in China

➤ **Rosun disinfectant powder DW-1**

- Application area : Drinking Water Disinfection
- Achievement :

1.Number of total waterworks: app.10000

2.Number of waterworks that use Rosun DW-1: app.600

3.The biggest handling capacity of waterwork :200,000 m³



Disinfection Object	Guide dosage	Contact Time	Instructions for use
City and Rural Area Tap water plant	0.3-1g/m ³	20-30min	Dissolve to 1%~2% solution by plastic drum, then add the solution in the water that need to treat by dosing pump continuously.
City Recycled water supply	1-1.5g/m ³	15-20min	
Bottled Water	0.2~0.5g/m ³	20-30min	
Emergency Water Disinfection (such as disaster area)	2-10g/m ³	20-30min	

➤ **Application Example(DW-1)**

Plant Name	Plant Scale (m ³)	Dosage (g/m ³)	Remark
Shandong Qingdao City Jimo Water Plant	80000	0.5	Pretreatment
Shandong Binzhou City East Sea Water Company	30000	0.4	After Treatment
Shandong Qingdao City Chengyang Water-Xiazhuang Waterworks	20000	0.7	Pre and After Treatment
Shandong Anqiu Hua'an Water Cooperation	8000	0.8	Pre and After Treatment
Anhui Huizhou District Water Plant	30000	0.5	After Treatment
Anhui Shexian Water Plant	30000	0.5	After Treatment
Anhui Yixian Water Plant	10000	0.25	After Treatment
Shanxi Hancheng Water Plant	20000	0.3	After Treatment
Shanxi Heyang Shendu Water Plant	10000	0.3	After Treatment
Fujian Unit 731146 Water Plant	8000	0.5	After Treatment

6

Study Case in Malaysia

➤ **Case Study 1 (Trusan Water Treatment Plant) 21st- 23rd September 2016**

- Designed water treatment capacity: 20000m³/day;
- Actual water treatment capacity: 23000m³/day;
- Average flow rate: 960m³/h
- Dosing equipment situation: Two 200gallon chemical dissolving tank. used by gravity flow dosing
- Dosage DW- 1: 1ppm as additive with Calcium hypo 1ppm
- Result:

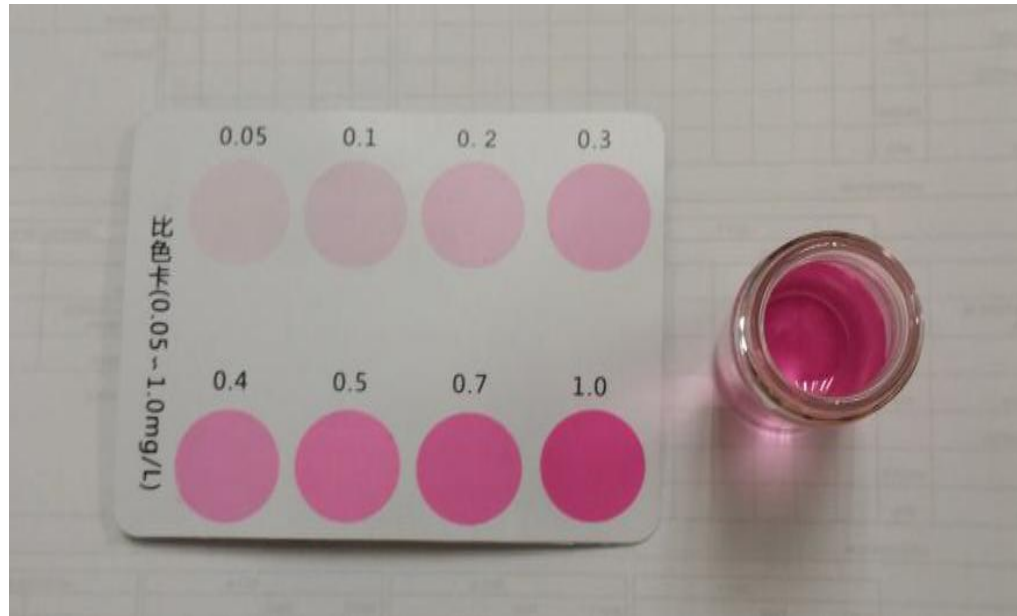

Free chlorine of finish water at WTP: 1ppm

- Result:



Free chlorine at terminal
water 30km away from
WTP: 0.55ppm



Free chlorine at terminal
water more than 50km
away from WTP: 0.23 ppm

Comparison between Calcium Hypochlorite and Rosun DW-1



Calcium Hypochlorite Solution



Rosun DW-1 Solution

**Terminal water (SK. Kpg Sebrang) In- Situ testing and water sampling for bacteria test
by Ministry of Health Officer**





PEJABAT KESIHATAN DAERAH LAWAS,
LOT 534, JALAN PENGIRAN HAJI MATUSIN,
98850 LAWAS.
SARAWAK.



Tel : 086-262234
Faks : 086-264837
Email : kmam_lawas@erwk.moh.gov.my

Ruj. Tuan :
Ruj. Kami : PKDLWSKMMAM7(32)
Tarikh : 29.09.2016

Jurutera Daerah,
Jabatan Bekalan Air Luar Bandar (JBALB),
98850 Lawas.

Tuan,
Makluman Keputusan Sampel Air Terawat semasa percubaan rawatan penggunaan ROSUN dalam air rawatan di LRA Trusan Regional.

Perkara tersebut diatas adalah dirujuk.

Untuk makluman pihak tuan/puan, bagi keputusan ujian mikrob dalam air terawat yang dilaksanakan bersama JRH Corporation dan diselia oleh pihak JBALB. Ada 4 point sampling yang diambil untuk ujian mikrob. Sampel tersebut diambil dan dihantar ke Jabatan Kimia Malaysia, Sabah dan juga ada dianalisa di Pejabat Kesihatan Daerah Lawas Makmal KMMAM Lawas.

Keputusan ujian adalah seperti berikut;

Tarikh	Masa	Tempat	T. Coliform	E. Coli	Baki Klorin	Catatan
22/09/2016	8.30 am	Market Lawas	0	0	0.55	Becaan Jab. Kimia
22/09/2016	10.17 am	SK Kpg Seberang	TNTC	0	0.38	Becaan Jab. Kimia
22/09/2016	2.30 pm	Market Lawas	0	0	0.55	KMMAM Lawas
22/09/2016	3.10 pm	SK Kpg Seberang	200.5mpn/100ml	50.4mpn/100ml	0.20	KMMAM Lawas
22/09/2016	4.05 pm	SMK Sundar	0	0	0.30	KMMAM Lawas
23/09/2016	2.30 pm	Market Lawas	0	0	0.10	KMMAM Lawas
23/09/2016	3.10 pm	SK Punang	3.1mpn/100ml	0	0.03	KMMAM Lawas
23/09/2016	4.05 pm	SK Kpg Seberang	0	0	0.11	KMMAM Lawas

Nota: Warna gelap adalah melanggar.

Sekian terima kasih,

"Penyayang, Profesionalisme dan Bekerja Berpasukan Adalah Budaya Kerja Kita"

Saya yang menurut perintah,

(DR. AZRINE BIN AZIZ)
Pegawai Kesihatan Daerah,
Pejabat Kesihatan Daerah Lawas.

Pikmanian.

• Comment:

• Proven reduction of bacteria (T. Coliform & E. Coli) at SK. Kpg Seberang. It was located more than 50 Km away from WTP with 1 water resevoir before supply to SK. Kpg Seberang.

• Other terminal water at market lawas and SMK Sundar which located within 30Km are totally free from bacteria after apply Rosun DW-1.

Case Study 2 (Felda Sahabat Loji C) 5 January – 9 January 2017

- Designed water treatment capacity: 20000m³/day;
- Actual water treatment capacity: 14400m³/day;
- Average flow rate: 600m³/h
- Dosing equipment situation: One 200 Liter chemical dissolving tank. used by gravity flow dosing.
- Dosage DW- 1: 1ppm as additive with Calcium hypo 0.7ppm



Rosun DW-1 Dosing by gravity flow on clarified water tank

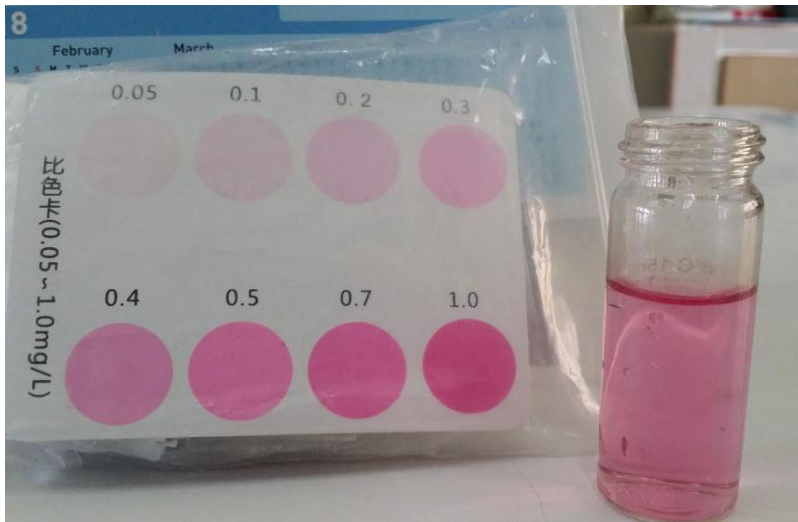

In- Situ Free Chlorine at Loji C
finish water: 1ppm



In- Situ Free Chlorine at SK.
Fajar Harapan Terminal water
20 Km away: 0.2ppm



Finish water at Loji C is collected and send to accredited laboratory to perform bacteria test.



With Loji C personnel and Ministry of Health Officer



Food & Environmental Testing

Lab No : BBR00174-175/0117E
 Company Name : NATIONCHEM SDN BHD
 Company Address : LOT 19, 1ST FLOOR, BLOCK C
 BUNDUSAN SQUARE, PENAMPANG
 JALAN BUNDUSAN
 88300 PENAMPANG, SABAH

Reference No : -
 Type Of Sample : WATER
 Date Of Sampling : 05.01.2017

Date Of Testing : 06.01.2017
 Date Of Report : 13.01.2017

Sample No : BBR174-175
 Date Received : 06.01.2017
 Date Of Request : 06.01.2017

CERTIFICATE OF ANALYSIS

Page 1 of 1

Sample Location : LOJI C (FINAL WATER)

Test Parameter	Unit	Before Dosing Rosun	After Dosing Rosun	Test Method
		BBR174	BBR175	
Free Residual Chlorine	mg/L	<0.1	<0.1	In House Method EWI-WC11
Total Coliform	MPN/100mL	2.8 x 10 ³	ND(<1.1)	APHA 9221 B
<i>Escherichia coli</i>	MPN/100mL	ND(<1.1)	ND(<1.1)	APHA 9221 F

Remark : (1) APHA : Standard Methods for the Examination of Water & Wastewater, 21st Edition (2005)



Food & Environmental Testing

Lab No : BBR00393/0117E
 Company Name : NATIONCHEM SDN BHD
 Company Address : LOT 19, 1ST FLOOR, BLOCK C
 BUNDUSAN SQUARE, PENAMPANG
 JALAN BUNDUSAN
 88300 PENAMPANG, SABAH
 Reference No : -
 Type Of Sample : WATER
 Date Of Sampling : 09.01.2017

Date Of Testing : 11.01.2017
 Date Of Report : 19.01.2017

Sample No : BBR393
 Date Received : 11.01.2017
 Date Of Request : 11.01.2017

CERTIFICATE OF ANALYSIS

Page 1 of 1

Sample Location : LOJI C (FINAL WATER)

Test Parameter	Unit	Loji C	Test Method
		BBR393	
Free Residual Chlorine	mg/L	<0.1	In House Method EWI-WC11
Total Coliform	MPN/100mL	ND(<1.1)	APHA 9221 B
<i>Escherichia coli</i>	MPN/100mL	ND(<1.1)	APHA 9221 F

Remark : (1) APHA : Standard Methods for the Examination of Water & Wastewater, 21st Edition (2005)
 (2) ND : Not Detected

Thank you

Chengdu Rosun Disinfection Pharmaceutical Co., Ltd

Makes The Rivers And Earth Cleaner , Helps Billions Of People Be Healthier

